



ALUMINIUM

DOG WALK

ASSEMBLY

INSTRUCTIONS

DOG WALK ASSEMBLY OVERVIEW

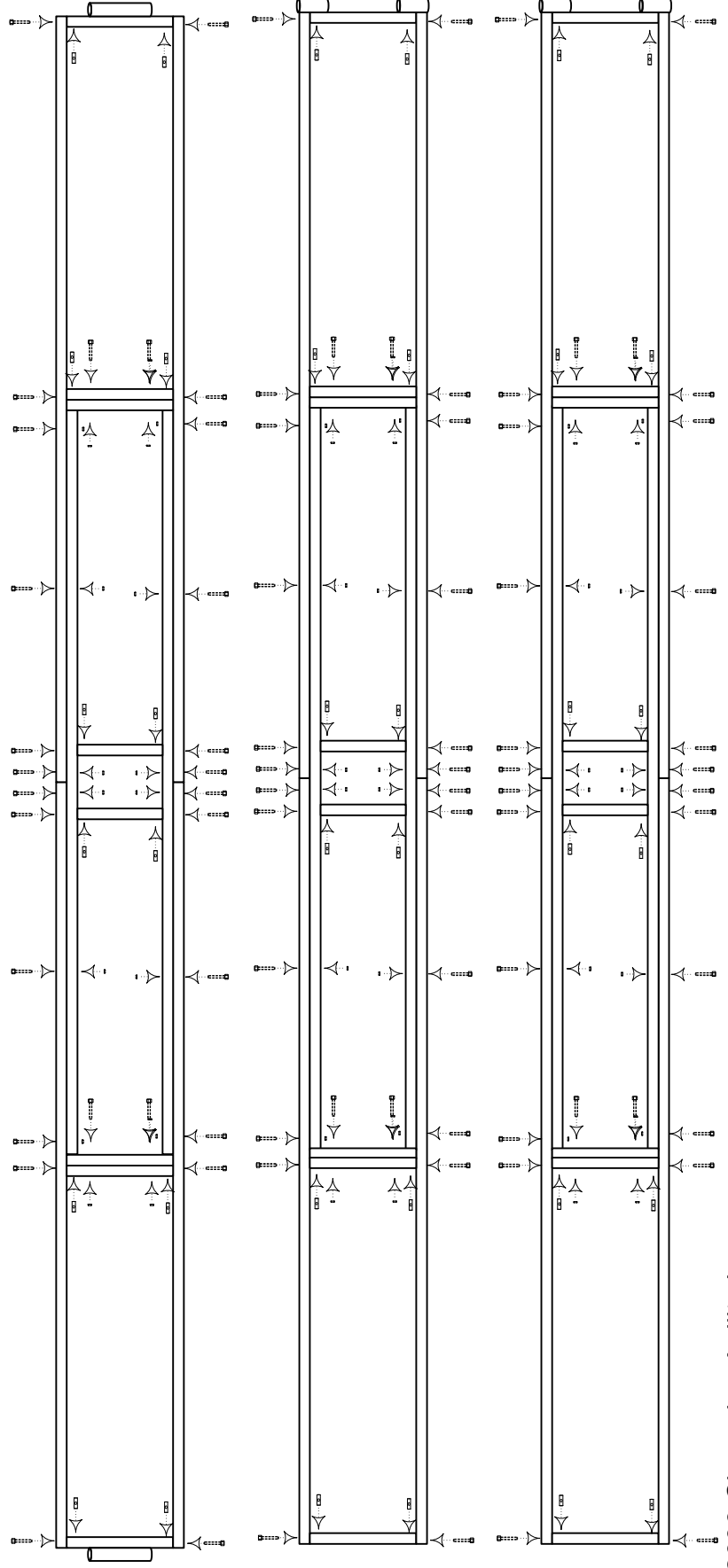



ALUMINIUM DOG WALK

PARTS LIST

- 1 Check the contained parts with the list
- 2 If parts are missing, logon to:
www.championagility.com and replacement parts will be shipped out to you.
- 3 You will require the following tools to assemble the Aluminum Teeter:
 - o Drill with a #2 Star Bit
 - o Two 7/16" Open Ended Wrenches or a couple of Crescent Wrenches
 - Paint
 - Sand
 - Paint Brushes

Note: It is sometimes useful to have a 1/4" Metal Drill Bit handy incase one of the holes do not match up properly. Just drill out the hole a little bit and continue assembly.

<u>Part</u>	<u>Description</u>	<u>Qty</u>
DW-0001	Main Plank Bars	12
DW-0002	Connector Bars	6
DW-0003	Leg Supports	4
DW-0004	Plank Connectors	14
DW-0005	Small Plank Connectors	6
DW-0006	Hinge 2	2
DW-0007	Hinge 1	2
DW-0008	Hinge Pins	2
DW-0009	Legs	4
DW-0010	Small Leg Cross Brace	2
DW-0011	Large Leg Cross Brace	2
DW-0012	Ramp Legs	4
DW-0013	Leg Connectors	4
DW-0014	Standoffs	60
DW-0015	Bracers	12
DW-0016	Support Connectors	4
DW-0017	Leg Support Cross Brace	2
HB-1000-2520	1.0" Hex Bolt	12
HB-1500-2520	1.5" Hex Bolt	16
HB-2000-2520	2.0" Hex Bolt	52
HB-2500-2520	2.5" Hex Bolt	44
HB-3000-2520	3.0" Hex Bolt	24
HB-3500-2520	3.5" Hex Bolt	4
CD-1250-2520	1-1/4" Cross Dowel	36
HN-2520	1/4" Hex Nut	112
BW-1250	1/4" Lock Washers	148
CP-1250	Cotter Pin	2
RC-1000	1" Rubber Caps	4
RC-0750	1" Nylon Insert Caps	8
TS-1000	Self Tapping Screws	225

DOG WALK PART
DIAGRAM

DW-0001 - 72" (x12)

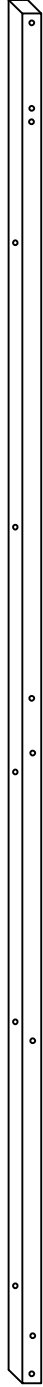

DW-0002 - 70" (x6)



DW-0003 (x4)

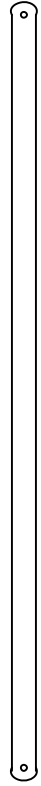

DW-0010 (x2)



DW-0009 - 49" (x4)



DW-0011 (x2)



DW-0004 - 10" (x14)



DW-0005 - 8" (x6)



DW-0006 - 10" (x2)

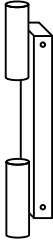

DW-0007 - 10" (x2)



DW-0008 (x2)

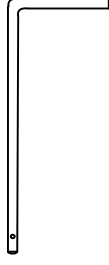

DW-0016 (x4)

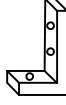

DW-0012 - 18.5" (x4)



DW-0013 - 1.5" (x4)



DW-0017 (x2)



DW-0014 - 1" (x60)



DW-0015 - 68" (x12)

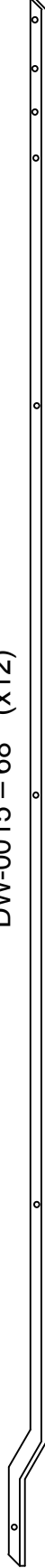

Attach two DW-0001 (Main Plank Bars) to one of the DW-0002 (Connector Braces) using four 2.5" Hex Bolts, four Lock Washers and four Hex Nuts. Repeat for the other side.

- Attach four DW-0004 (Plank Connectors) to the Plank bars from (4) using eight 2.0" Hex Bolts, eight Lock Washers, four Cross Dowels and four Hex Nuts. Note: this is a bit tricky to do. We suggest you attach the two Plank Connectors closest to the Connector Braces first and then attach the other two. They fit very tightly together. Note for the inside DW-0004, you do not use Cross Dowels.
- Next attach two DW-0005 (Small Plank Connectors) using four 2.5" Hex Bolts, four Lock Washers and four Cross Dowels.

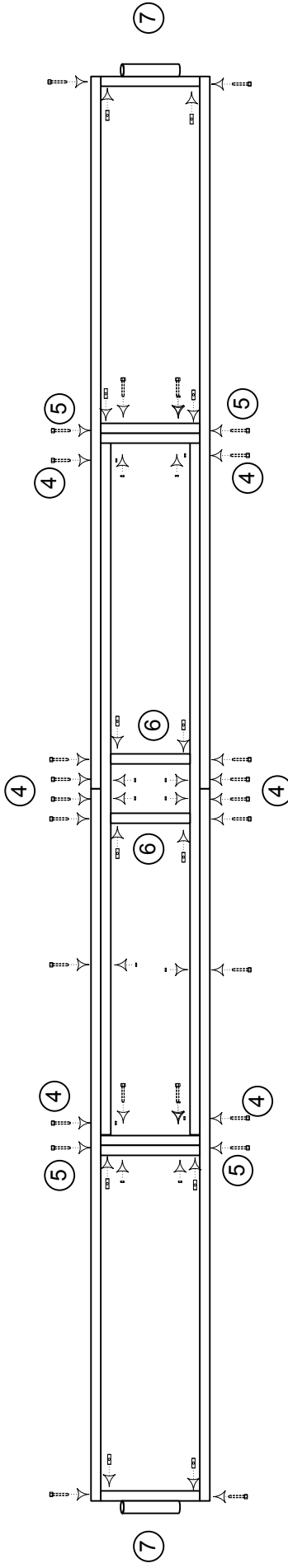

- Attach the two DW-0007 (Hinge 1) using four 2.0" Hex Bolts, four Lock Washers and four Cross Dowels.
- Repeat steps (4) through (7) for the other two planks. In step (7) replace the two DW-0007 with one DW-0006 and one DW-0004.

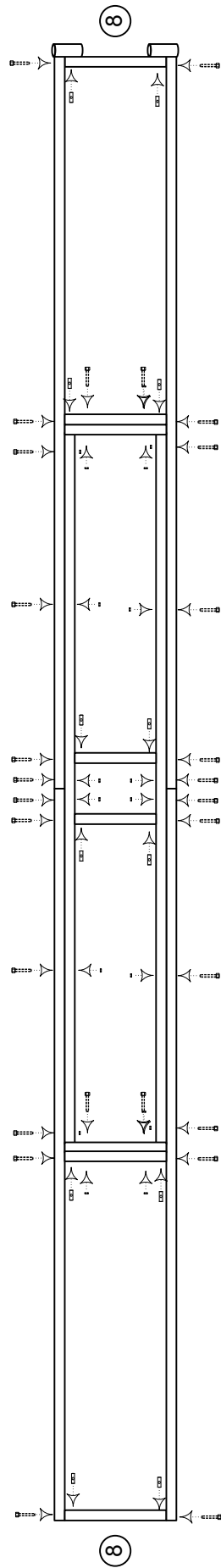

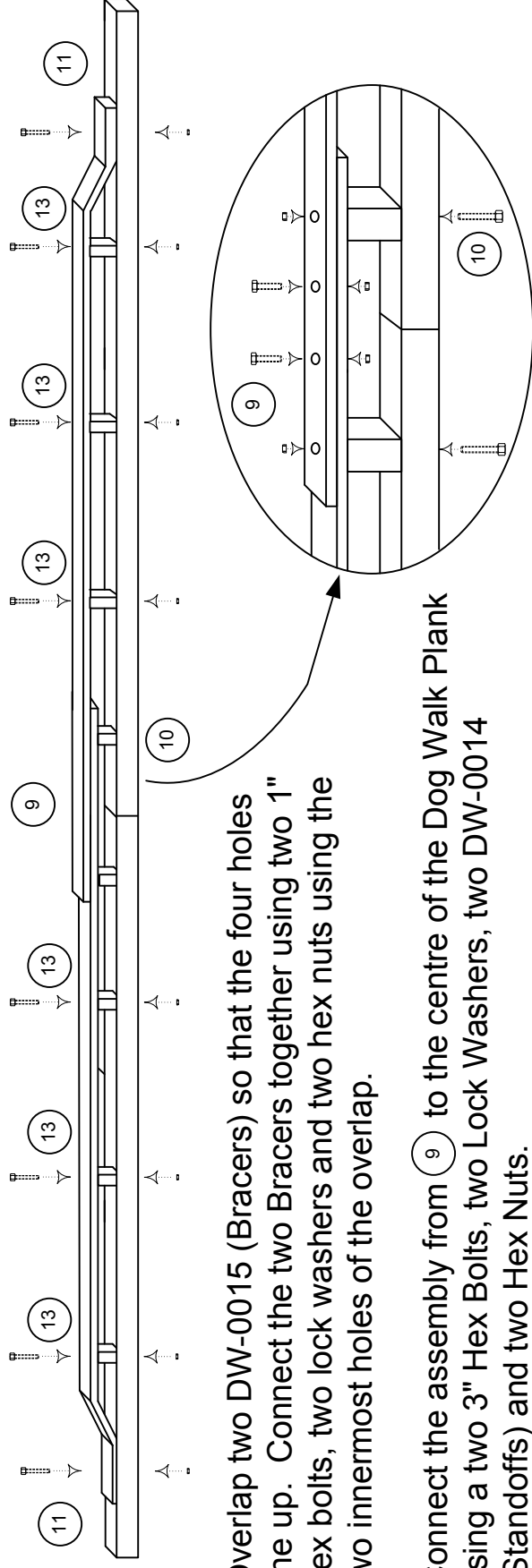

- 9 Overlap two DW-0015 (Bracers) so that the four holes line up. Connect the two Bracers together using two 1" hex bolts, two lock washers and two hex nuts using the two innermost holes of the overlap.
- 10 Connect the assembly from 9 to the centre of the Dog Walk Plank using a two 3" Hex Bolts, two Lock Washers, two DW-0014 (Standoffs) and two Hex Nuts.
- 11 Connect the ends of the assembly from 9 to the Dog Walk Plank using two 1.5" Bolts, two Lock Washers and two Hex Nuts.
- 13 Connect the rest of the the assembly from 9 to the Dog Walk Plank using six 2.5" Bolts, six Lock Washers, six DW-0014 (Standoffs) and six Hex Nuts.
- 14 Repeat 9 through 13 for the other side.
- 15 Repeat 9 through 14 for the other two planks.

- 15 Attach two DW-0009 (Legs) to two DW-0010 (Small Leg Cross Brace) using two 2.5" Hex Bolts, two Lock Washers and two Hex Nuts.
- 16 Attach two DW-0011 (Large Leg Cross Braces) to the DW-0009 (Legs) using two 2.5" Hex Bolts, two Lock Washers and two Hex Nuts.
- 17 Attach two DW-0016 (Support Connector) to the DW-0011 using four 1.5" Hex Bolts, four Lock Washers and four Hex Nuts.
- 18 Repeat steps 15 through 17 for the other side.
- 19 Attach the four DW-0013 (Leg Connectors) to the Main Dog Walk Plank using four 2.0" Hex Bolts, four Lock Washers and four Hex Nuts. Push the Hex Bolt from the inside of the Dog Walk Plank towards the outside and put the Hex Nut on the outside of the plank.

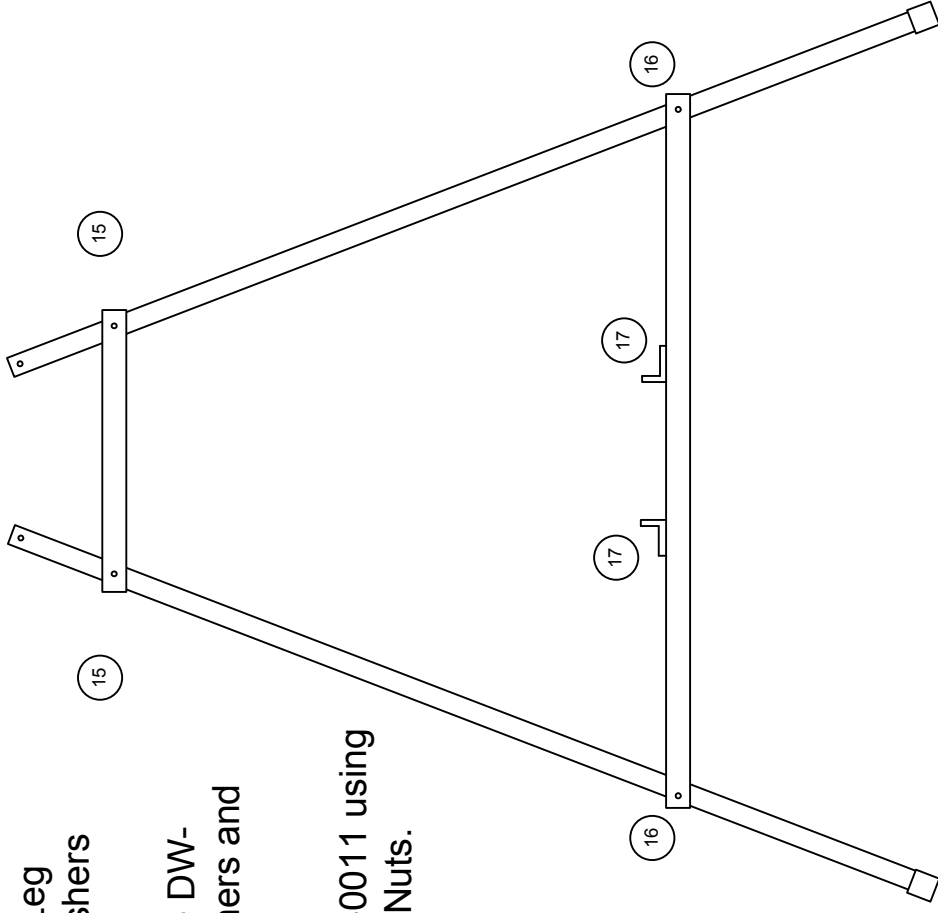
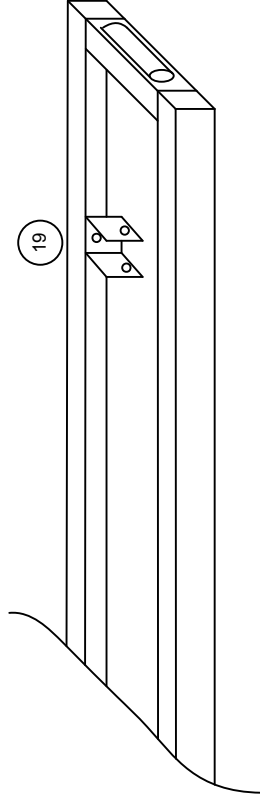

20 Insert a 1" Nylon Safety plug into each end of the Leg Cross Braces. Attach a 1" Rubber Cap to the bottom of each DW-0009 (Leg).

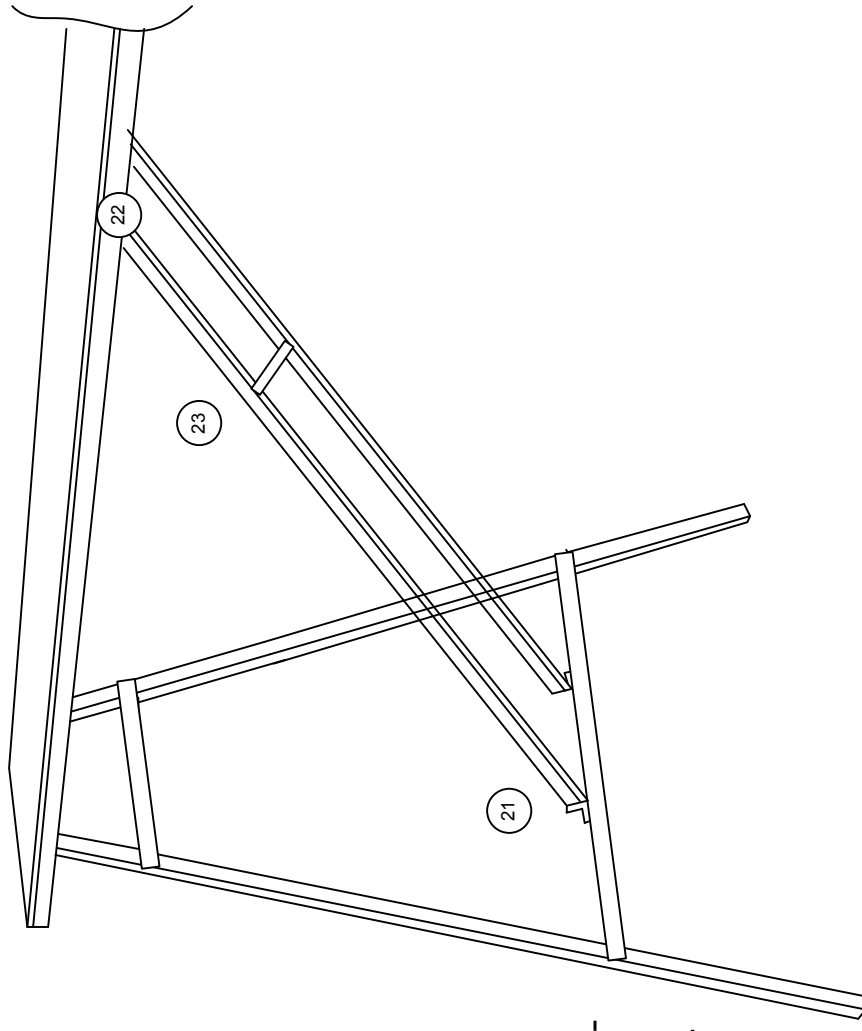

- 21 Attach one end of two DW-0003 (Leg Supports) to the two DW-0016 (Support Connectors) using two 2.0" Hex Bolts, two Lock Washers and two Hex Nuts.
- 22 Attach the other end of the two DW-0003 (Leg Supports) to the min plank using two 3.5" Hex Bolts, two Lock Washers and two Hex Nuts.
- 23 Connect the two DW-0003 (Leg Supports) to a DW-0017 (Leg Support Cross Brace) using two Cross Dowels, two 2.0" Hex Bolts and two Lock Washers.

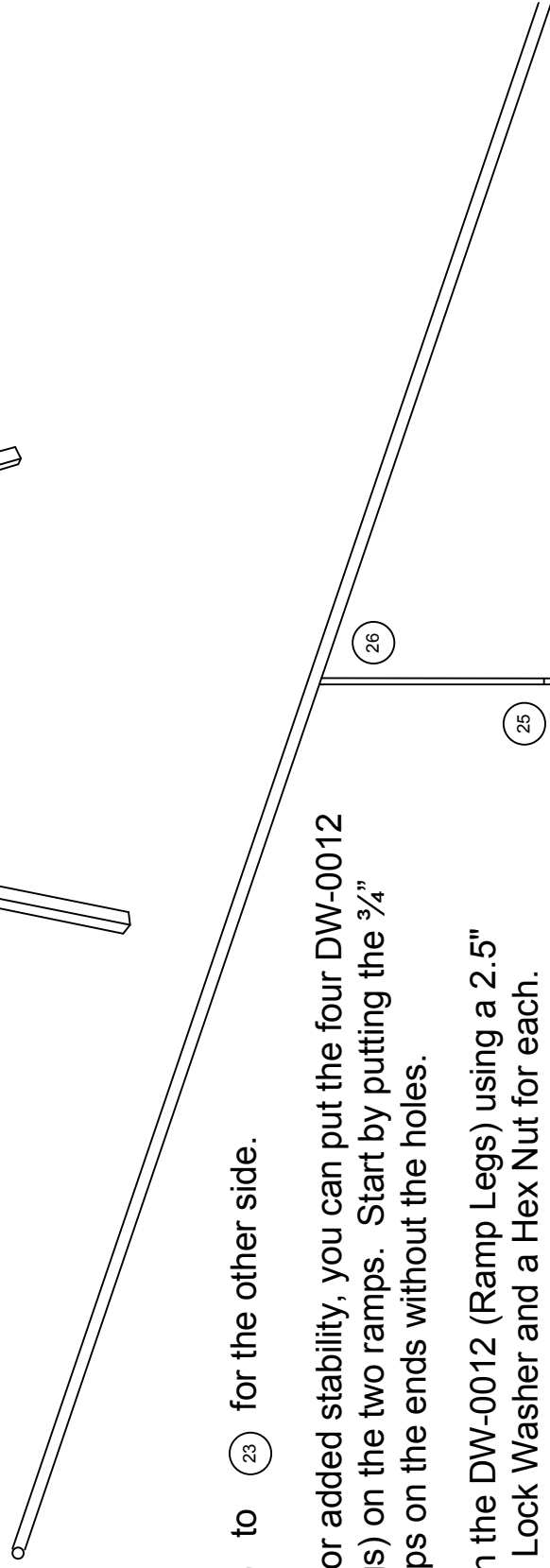

- 24 Repeat 21 to 23 for the other side.
- 25 Optional: for added stability, you can put the four DW-0012 (Ramp Legs) on the two ramps. Start by putting the 3/4" Rubber Caps on the ends without the holes.
- 26 Then attach the DW-0012 (Ramp Legs) using a 2.5" Hex Bolt, a Lock Washer and a Hex Nut for each.

- 27 Using the 1" Self Tapping Screws, attach the plywood to the Dog Walk Plank and Ramps. Start with one of the 3 foot by 12 inch pieces at the bottom of the Plank or Ramps. Use screws every 6 inches.
- 28 Then attach one of the 6 foot by 12 inch pieces.
- 29 Then attach one of the 3 foot by 12 inch pieces at the top of the Plank or Ramps.

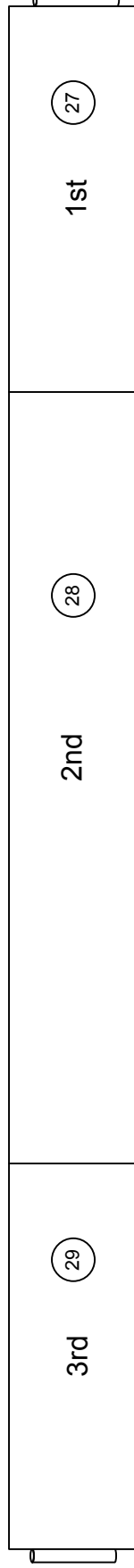

- 30 Mix Sand with the two colors of paint you have chosen for your Dog Walk (yellow for the contact and the other color you have chosen). Apply the yellow sanded paint to the contact zones (usually 36" to 42" from the end) and the other color to the top zone. Apply a liberal amount of sanded paint to the areas where the self tapping screws attach the plywood to the support and to the centers where two pieces of plywood join.
- 31 When the paint is dry, use the DW-0008 (Hinge Pins) to connect the Ramps with the Plank. Use the Cotter Pins to secure the Hinge Pins.



Warranty

1. For one year from the date of the original retail purchase. CHAMPION AGILITY warrants to the original purchaser of any CHAMPION AGILITY product that, should it prove defective by reason of improper workmanship and/or material, CHAMPION AGILITY will repair or replace, at its option, any defective part of the product, without charge for the part or the shipping. Replacement parts are warranted for the remainder of the original warranty period.

NOTE: If you discover that any pieces to your CHAMPION AGILITY product are missing when you unpack it, please visit www.championagility.com and the missing piece(s) will be sent to you at no charge.

2. THIS WARRANTY DOES NOT COVER defects in the equipment caused by the original purchaser or any third party, or any defects arising or discovered more than one year from the original retail purchase date. This Warranty is void if the equipment is modified in any way.

3. STEPS TO OBTAIN WARRANTY SERVICE:

A. The purchaser must e-mail CHAMPION AGILITY at sales@championagility.com, to report the alleged defect to a customer service representative.

B. The customer service representative will determine if the defect is covered by this warranty and if it is, will authorize and instruct the purchaser in how to obtain corrective action.

C. CHAMPION AGILITY may require the purchaser to present the sales receipt or other proof of purchase prior to authorizing any return or replacement. No returns or replacements will be permitted without proper authorization. If a return or replacement is authorized, you may be requested to return the item to CHAMPION AGILITY or to make the item available for pick-up by CHAMPION AGILITY.

4. ANY EXPRESS WARRANTY NOT PROVIDED IN THIS WARRANTY DOCUMENT AND ANY REMEDY FOR BREACH OF CONTRACT THAT, BUT FOR THIS PROVISION, MIGHT ARISE BY IMPLICATION OR OPERATION OF LAW, IS HEREBY EXCLUDED AND DISCLAIMED. THE IMPLIED WARRANTIES OF MERCHANT ABILITY AND OF FITNESS FOR ANY PARTICULAR PURPOSE ARE EXPRESSLY LIMITED TO TERM OF ONE YEAR.

5. UNDER NO CIRCUMSTANCES SHALL CHAMPION AGILITY BE LIABLE TO PURCHASER OR ANY OTHER PERSON OR ANY SPECIAL, INCIDENTAL OR CONSEQUENTIAL DAMAGES, WHETHER ARISING OUT OF BREACH OF WARRANTY, BREACH OF CONTRACT OR OTHERWISE.